



REPUBLIC OF THE PHILIPPINES
OFFICE OF THE PRESIDENT
METROPOLITAN MANILA DEVELOPMENT AUTHORITY
(Pangasiwaan Sa Pagpapaunlad Ng Kalakhang Maynila)
ISO 9001: 2015 CERTIFIED



***Proposed Landscape Treatment Pocket Park @ EDSA Quezon Avenue
underneath Flyover Center Island, Quezon City (Package No. 4)***

BID BULLETIN NO. 1

November 15, 2021

All prospective bidders are hereby informed of the following amendment/s and/or clarifications for the above stated project;

- A. Schedule of Site Inspection is on November 17, 2021 at 9:00 a.m. meeting place is at EDSA-Tramo.
- B. Section III. Bid Data Sheet ITB Clause 10.4 -Requires the presence of both Project Engineer and Architect to do the structural and architectural works.
- C. Section II-Instructions to Bidders #16 Sealing and Markings of Bid- There are no additional copies, hard or electronic, of the Bid Proposal required.
- D. Section III. Bid Data Sheet ITB Clause 10.4-The list of key personnel to be assigned/dedicated to the project, with their complete qualification and experience as stated in the ITB. When these personnel are assigned to a particular project, they must be available during the project duration such that the project schedule is strictly observed, without delay.
- E. Section III. Bid Data Sheet ITB Clause 10.3- Required PCAB License for the project is under Medium A size range and License Category "B" and above
- F. Section VII. Drawings- See attached document.
- G. Copy of Minutes Pre-Bid Conference can be acquired at Office of the BAC Secretariat.

This Bid Bulletin shall form an integral part of the bid documents for the project.

USEC FRISCO SAN JUAN JR.
BAC Chairman

PERSPECTIVE VIEWS OF PROPOSED EDSA POCKET PARK FOR THE FIVE (5) PACKAGES

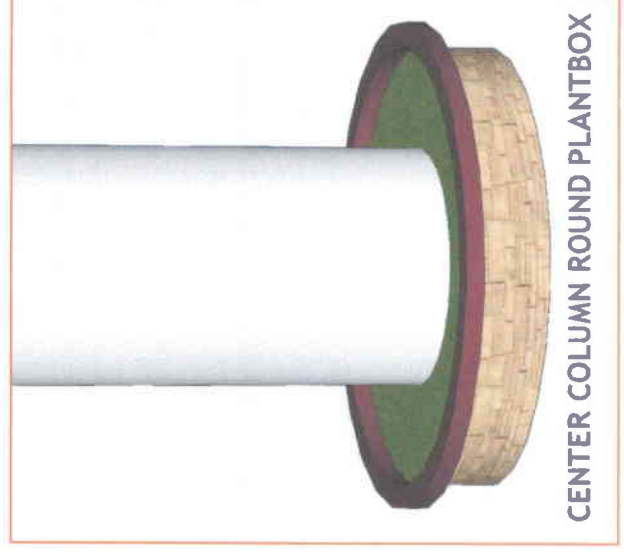
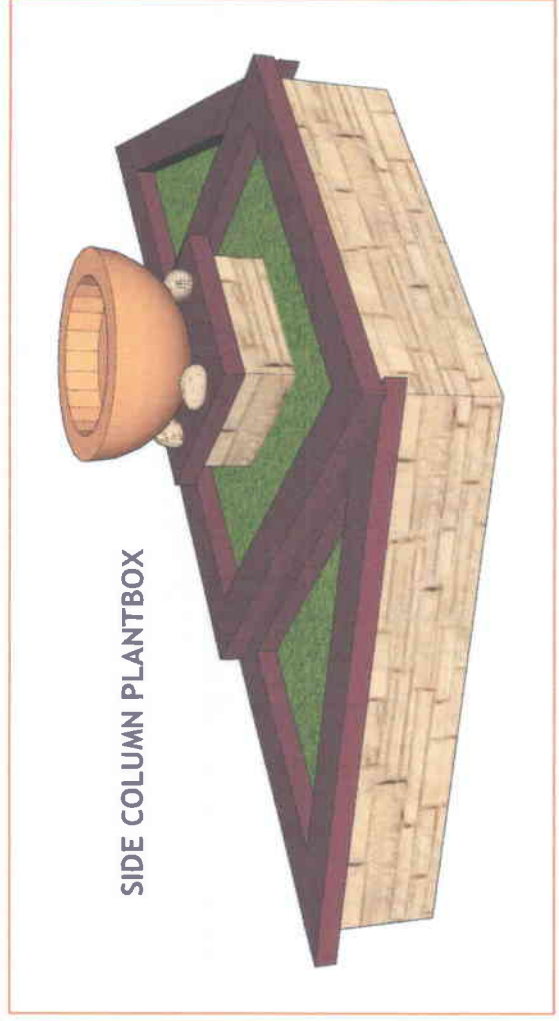
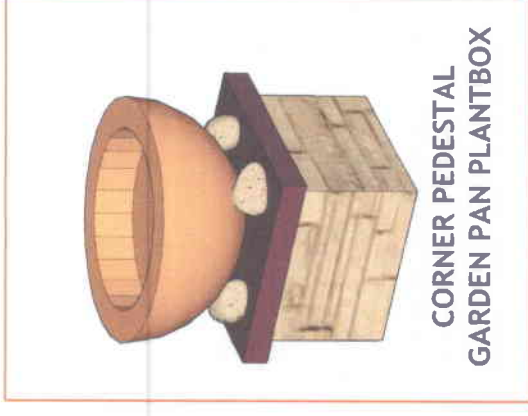

PERSPECTIVE VIEWS OF PROPOSED EDSA POCKET PARK FOR
THE FIVE (5) PACKAGES

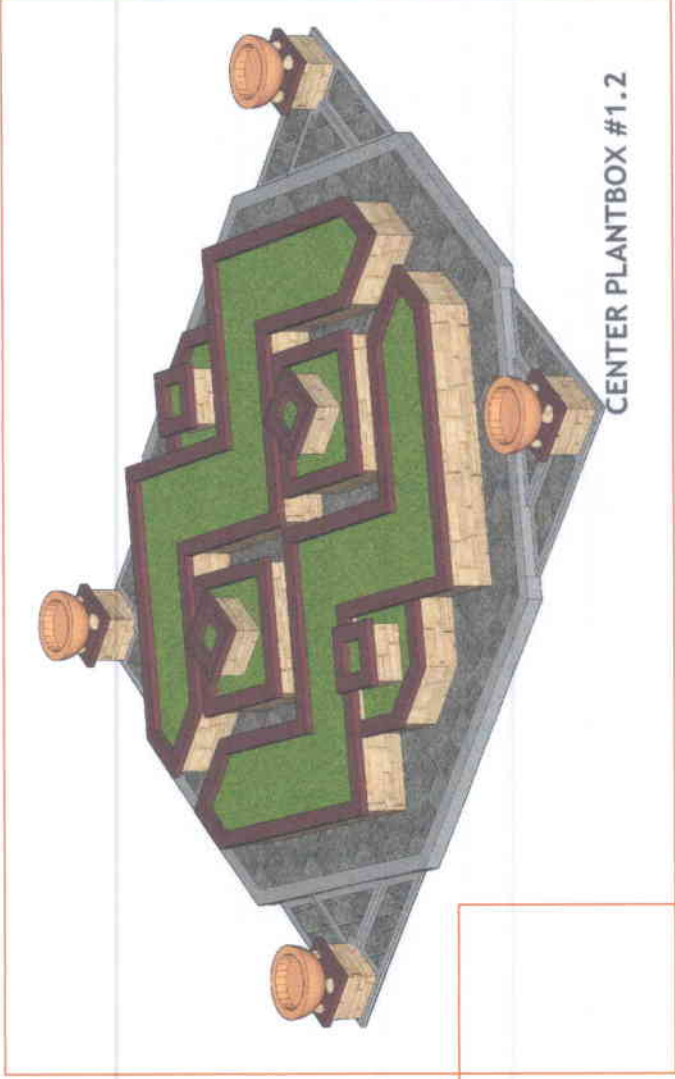

PERSPECTIVE VIEWS OF PROPOSED EDSA POCKET PARK FOR THE FIVE (5) PACKAGES

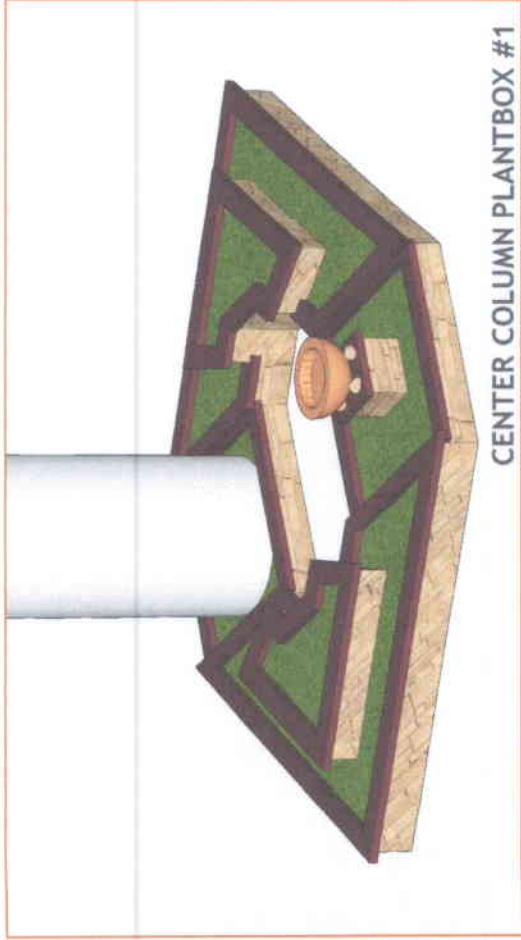

CENTER COLUMN PLANTBOX #1



CENTER COLUMN PLANTBOX #2

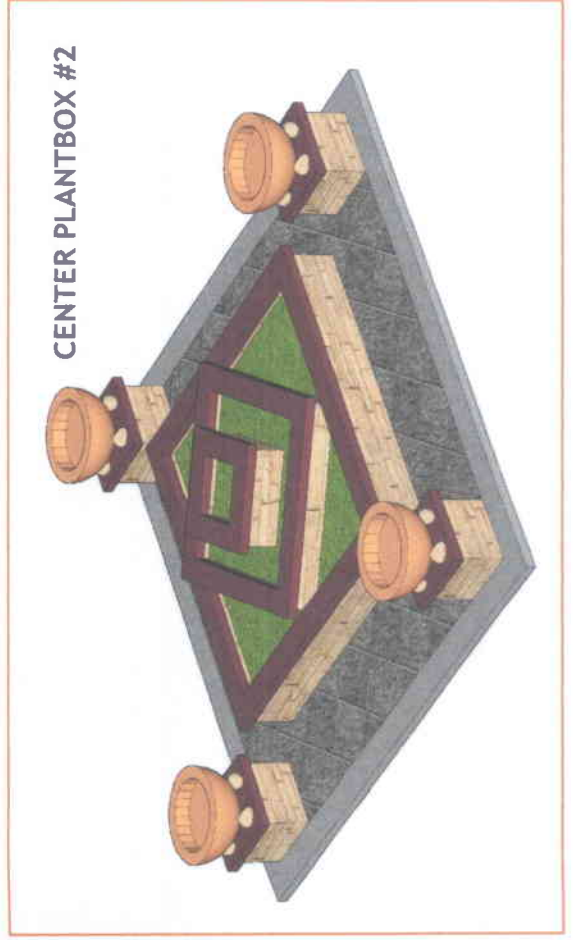

CENTER PLANTBOX #2

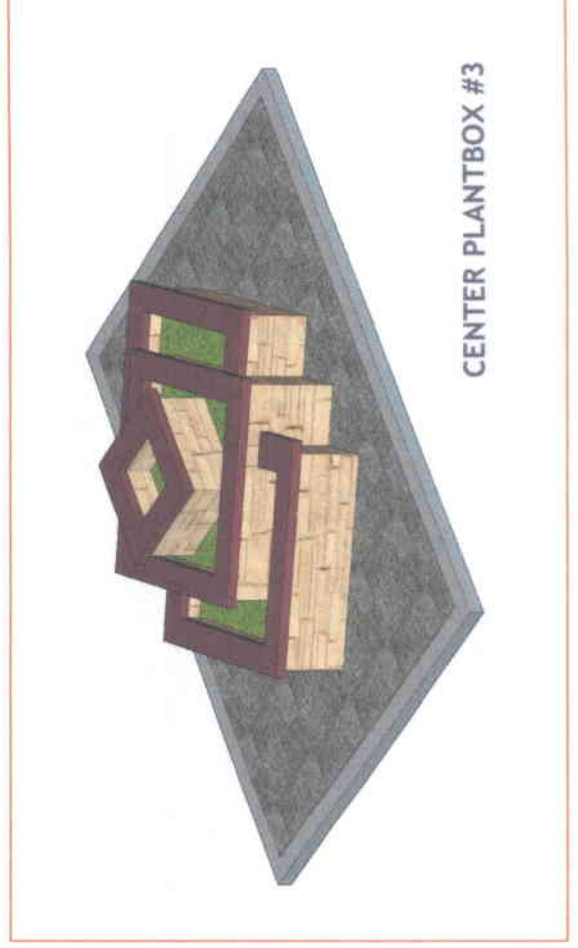

CENTER PLANTBOX #3

DETAILED DIMENSIONS OF PROPOSED EDSA POCKET PARK FOR THE FIVE (5) PACKAGES

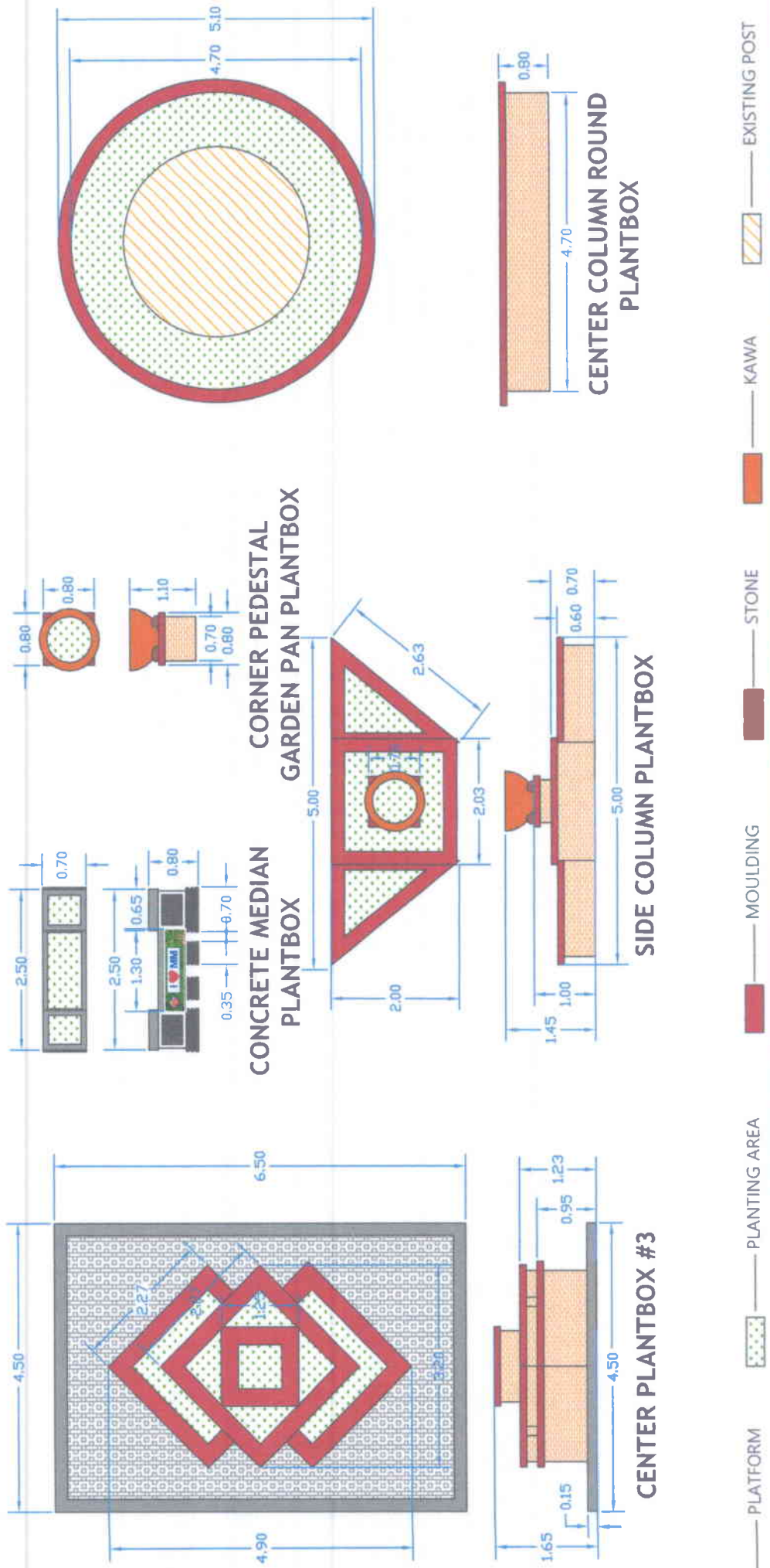

LEGEND:

-  PLATFORM
-  PLANTING AREA
-  MOULDING
-  STONE
-  KAWA
-  EXISTING POST

DETAILED DIMENSIONS OF PROPOSED EDSA POCKET PARK FOR THE FIVE (5) PACKAGES

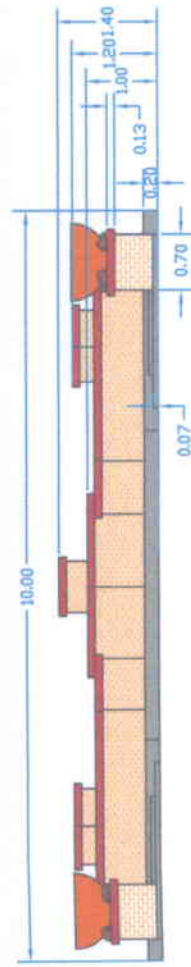
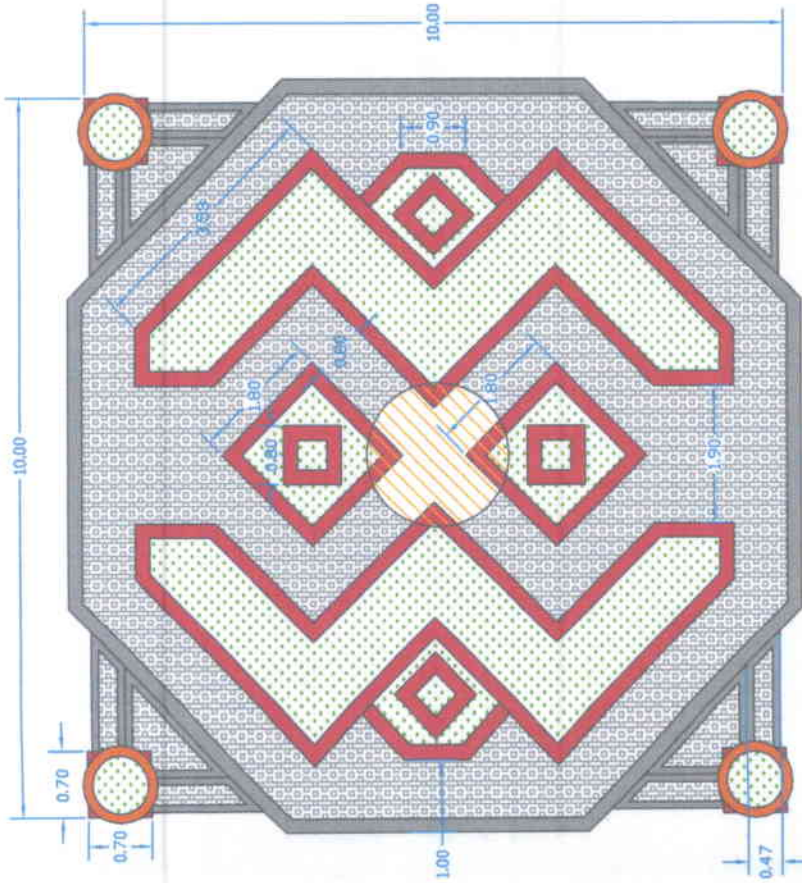

CENTER PLANTBOX #1 (OPTION 1)

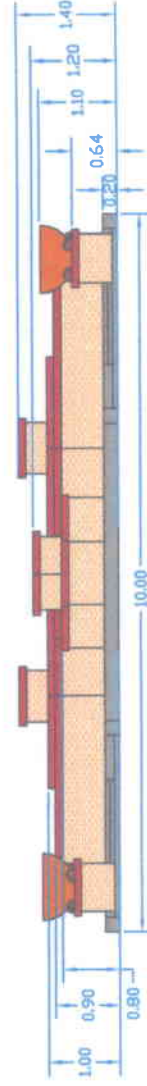
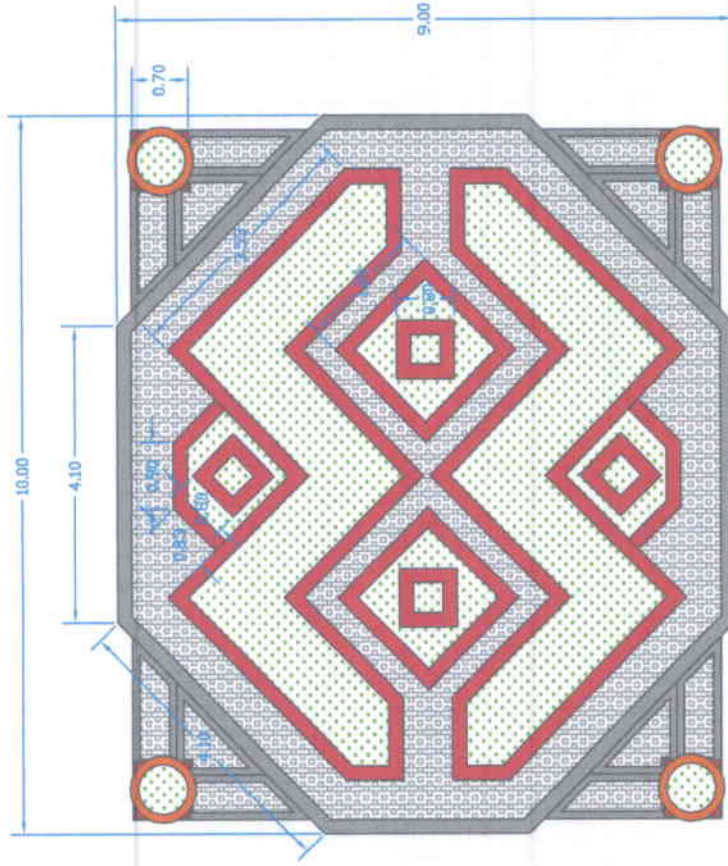

CENTER PLANTBOX #1 (OPTION 2)

LEGEND:

-  PLATFORM
-  PLANTING AREA
-  MOULDING
-  STONE
-  KAWA
-  EXISTING POST

DETAILED DIMENSIONS OF PROPOSED EDSA POCKET PARK FOR THE FIVE (5) PACKAGES

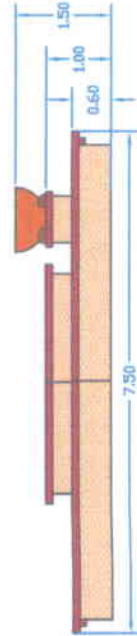
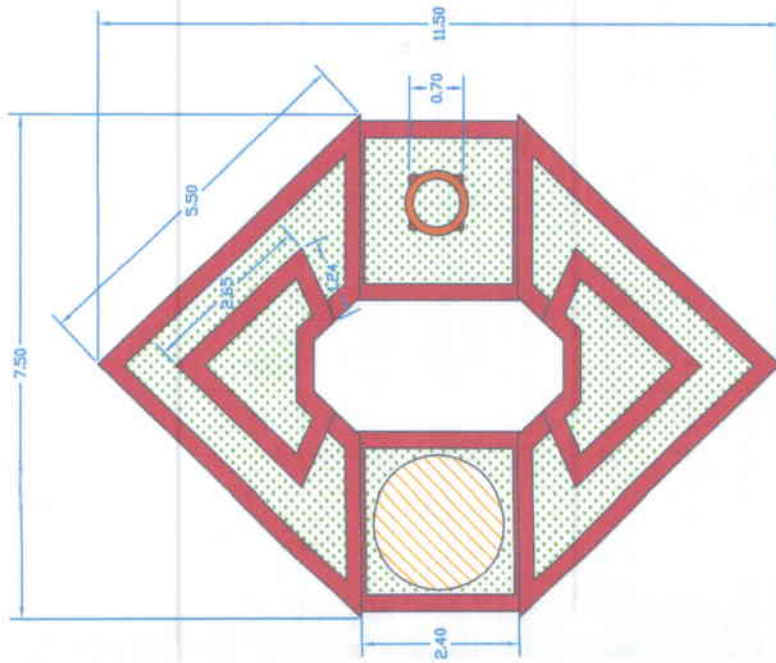

CENTER COLUMN PLANTBOX #1

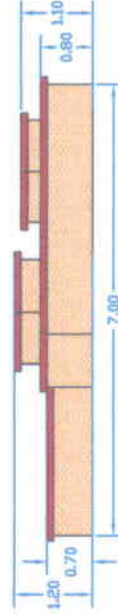
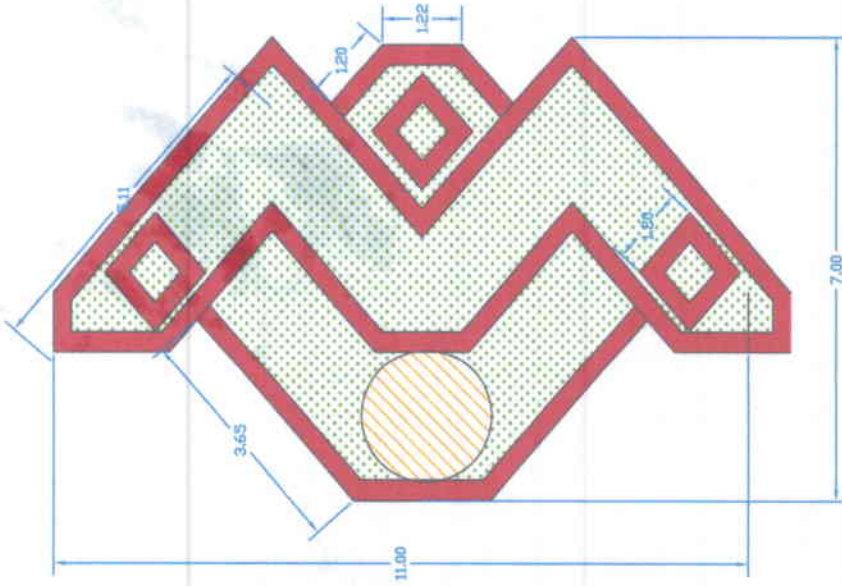

CENTER COLUMN PLANTBOX #2

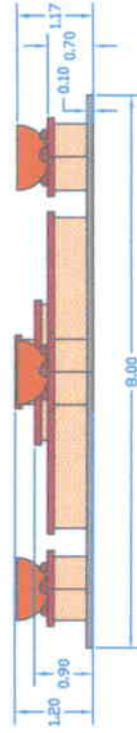
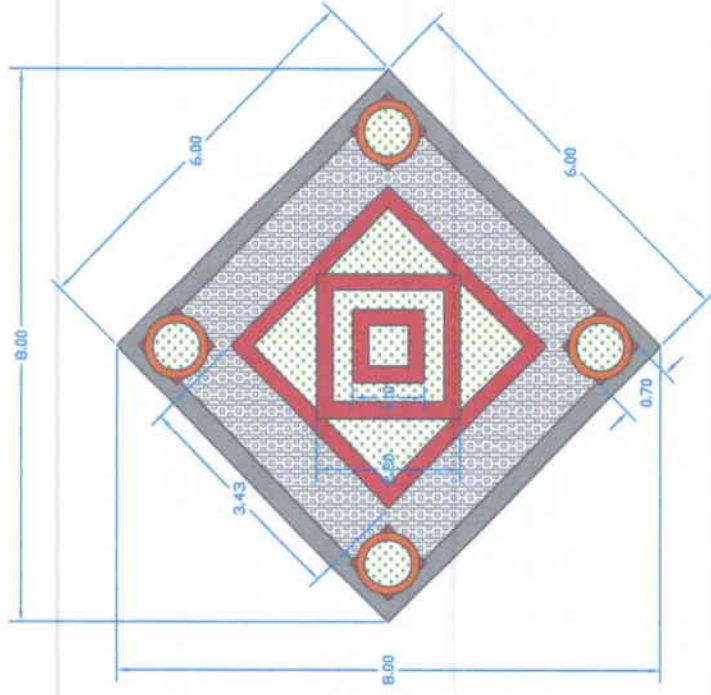

CENTER PLANTBOX #2

LEGEND:



PLATFORM



PLANTING AREA



MOULDING



STONE



KAWA



EXISTING POST